

MJE15028, MJE15030 (NPN), MJE15029, MJE15031 (PNP)



ON Semiconductor®

<http://onsemi.com>

Complementary Silicon Plastic Power Transistors

These devices are designed for use as high-frequency drivers in audio amplifiers.

Features

- High Current Gain – Bandwidth Product
- TO-220 Compact Package
- These Devices are Pb-Free and are RoHS Compliant*

MAXIMUM RATINGS

Rating	Symbol	Value	Unit
Collector–Emitter Voltage MJE15028G, MJE15029G MJE15030G, MJE15031G	V_{CE0}	120 150	Vdc
Collector–Base Voltage MJE15028G, MJE15029G MJE15030G, MJE15031G	V_{CB}	120 150	Vdc
Emitter–Base Voltage	V_{EB}	5.0	Vdc
Collector Current – Continuous	I_C	8.0	Adc
Collector Current – Peak	I_{CM}	16	Adc
Base Current	I_B	2.0	Adc
Total Device Dissipation @ $T_C = 25^\circ\text{C}$ Derate above 25°C	P_D	50 0.40	W W/ $^\circ\text{C}$
Total Device Dissipation @ $T_A = 25^\circ\text{C}$ Derate above 25°C	P_D	2.0 0.016	W W/ $^\circ\text{C}$
Operating and Storage Junction Temperature Range	T_J, T_{stg}	-65 to +150	$^\circ\text{C}$

Stresses exceeding those listed in the Maximum Ratings table may damage the device. If any of these limits are exceeded, device functionality should not be assumed, damage may occur and reliability may be affected.

THERMAL CHARACTERISTICS

Characteristics	Symbol	Max	Unit
Thermal Resistance, Junction-to-Case	$R_{\theta JC}$	2.5	$^\circ\text{C/W}$
Thermal Resistance, Junction-to-Ambient	$R_{\theta JA}$	62.5	$^\circ\text{C/W}$

8 AMPERE POWER TRANSISTORS COMPLEMENTARY SILICON 120–150 VOLTS, 50 WATTS

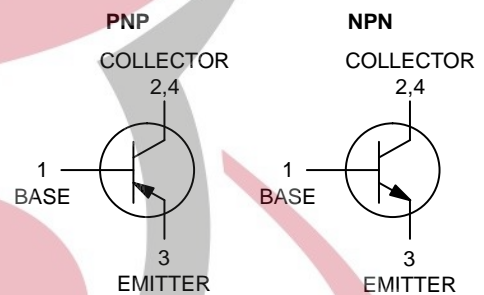

TO-220
CASE 221A
STYLE 1

MARKING DIAGRAM



MJE150xx = Device Code
x = 28, 29, 30, or 31
A = Assembly Location
Y = Year
WW = Work Week
G = Pb-Free Package

ORDERING INFORMATION

See detailed ordering and shipping information in the package dimensions section on page 5 of this data sheet.

*For additional information on our Pb-Free strategy and soldering details, please download the ON Semiconductor Soldering and Mounting Techniques Reference Manual, SOLDERRM/D.

MJE15028, MJE15030 (NPN), MJE15029, MJE15031 (PNP)

ELECTRICAL CHARACTERISTICS (T_C = 25°C unless otherwise noted)

Characteristic	Symbol	Min	Max	Unit
OFF CHARACTERISTICS				
Collector–Emitter Sustaining Voltage (Note 1) (I _C = 10 mA, I _B = 0) MJE15028, MJE15029 MJE15030, MJE15031	V _{CEO(sus)}	120 150	– –	Vdc
Collector Cutoff Current (V _{CE} = 120 Vdc, I _B = 0) MJE15028, MJE15029 (V _{CE} = 150 Vdc, I _B = 0) MJE15030, MJE15031	I _{CEO}	– –	0.1 0.1	mA
Collector Cutoff Current (V _{CB} = 120 Vdc, I _E = 0) MJE15028, MJE15029 (V _{CB} = 150 Vdc, I _E = 0) MJE15030, MJE15031	I _{CBO}	– –	10 10	μA
Emitter Cutoff Current (V _{BE} = 5.0 Vdc, I _C = 0)	I _{EBO}	–	10	μA
ON CHARACTERISTICS (Note 1)				
DC Current Gain (I _C = 0.1 A, V _{CE} = 2.0 Vdc) (I _C = 2.0 A, V _{CE} = 2.0 Vdc) (I _C = 3.0 A, V _{CE} = 2.0 Vdc) (I _C = 4.0 A, V _{CE} = 2.0 Vdc)	h _{FE}	40 40 40 20	– – – –	–
DC Current Gain Linearity (V _{CE} From 2.0 V to 20 V, I _C From 0.1 A to 3 A) (NPN to PNP)	h _{FE}		Typ 2 3	
Collector–Emitter Saturation Voltage (I _C = 1.0 A, I _B = 0.1 A)	V _{CE(sat)}	–	0.5	Vdc
Base–Emitter On Voltage (I _C = 1.0 A, V _{CE} = 2.0 Vdc)	V _{BE(on)}	–	1.0	Vdc
DYNAMIC CHARACTERISTICS				
Current Gain – Bandwidth Product (Note 2) (I _C = 500 mA, V _{CE} = 10 Vdc, f _{test} = 10 MHz)	f _T	30	–	MHz

Product parametric performance is indicated in the Electrical Characteristics for the listed test conditions, unless otherwise noted. Product performance may not be indicated by the Electrical Characteristics if operated under different conditions.

1. Pulse Test: Pulse Width ≤ 300 μs, Duty Cycle ≤ 2.0%.
2. $f_T = |h_{FE}| \cdot f_{test}$.

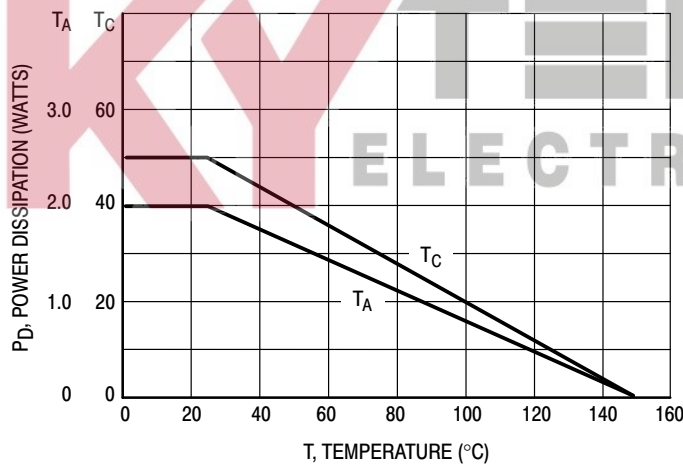

Figure 1. Power Derating

MJE15028, MJE15030 (NPN), MJE15029, MJE15031 (PNP)

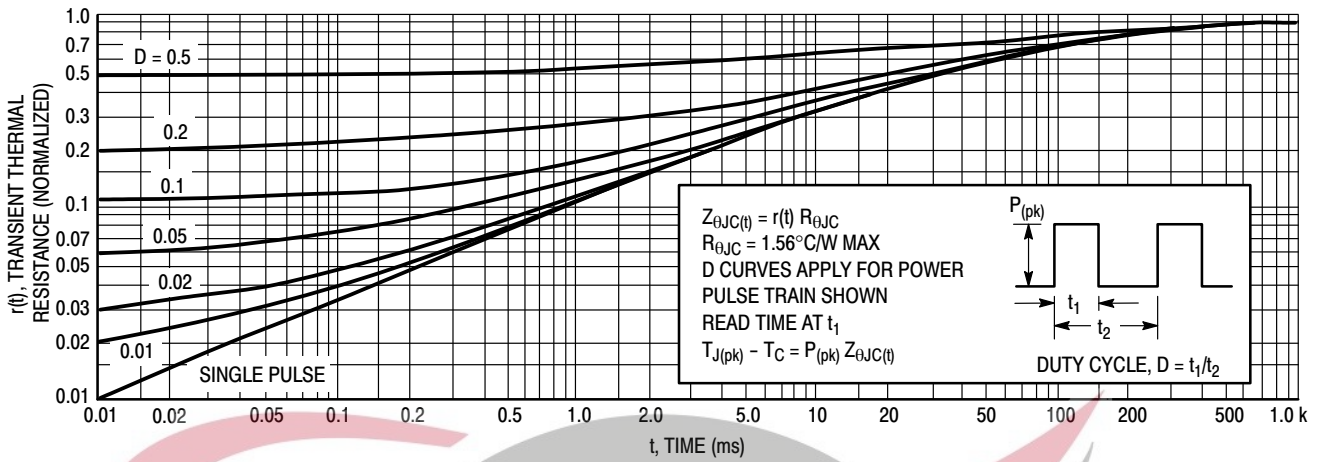

Figure 2. Thermal Response

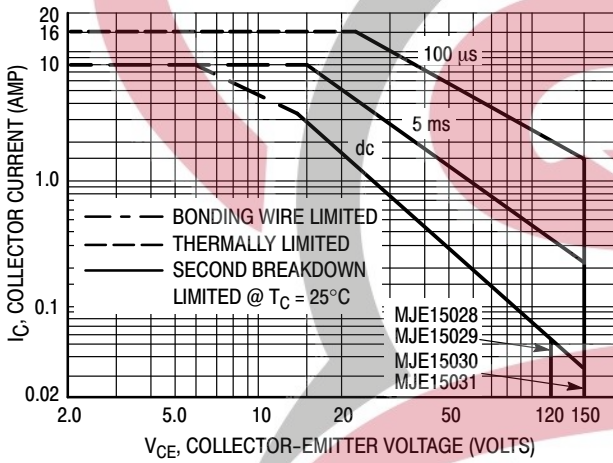

Figure 3. Forward Bias Safe Operating Area

There are two limitations on the power handling ability of a transistor: average junction temperature and second breakdown. Safe operating area curves indicate $I_C - V_{CE}$ limits of the transistor that must be observed for reliable operation, i.e., the transistor must not be subjected to greater dissipation than the curves indicate.

The data of Figures 3 and 4 is based on $T_{J(pk)} = 150^{\circ}\text{C}$; T_C is variable depending on conditions. Second breakdown pulse limits are valid for duty cycles to 10% provided $T_{J(pk)} < 150^{\circ}\text{C}$. $T_{J(pk)}$ may be calculated from the data in Figure 2. At high case temperatures, thermal limitations will reduce the power that can be handled to values less than the limitations imposed by second breakdown.

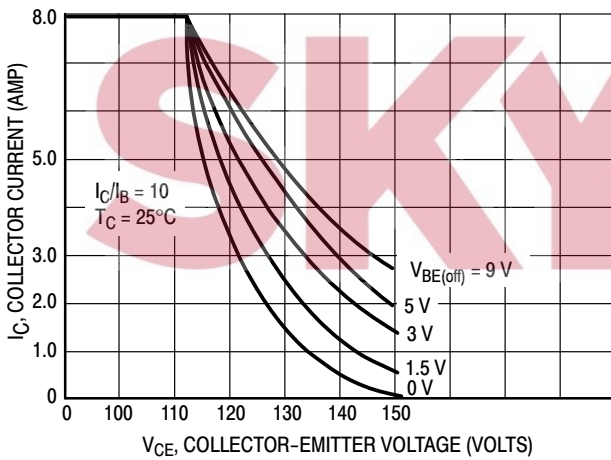

Figure 4. Reverse-Bias Switching Safe Operating Area

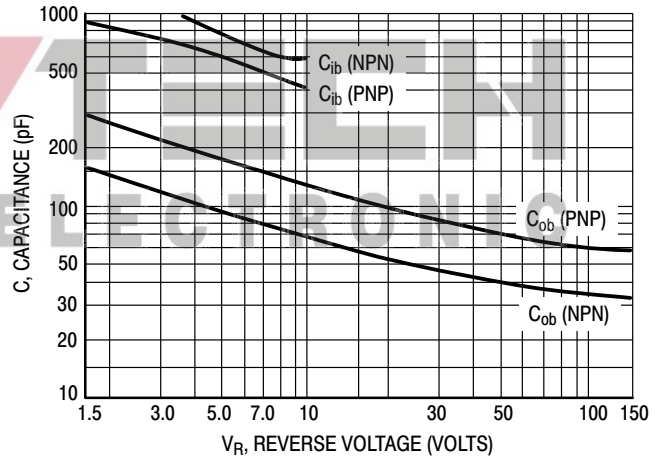

Figure 5. Capacitances

MJE15028, MJE15030 (NPN), MJE15029, MJE15031 (PNP)

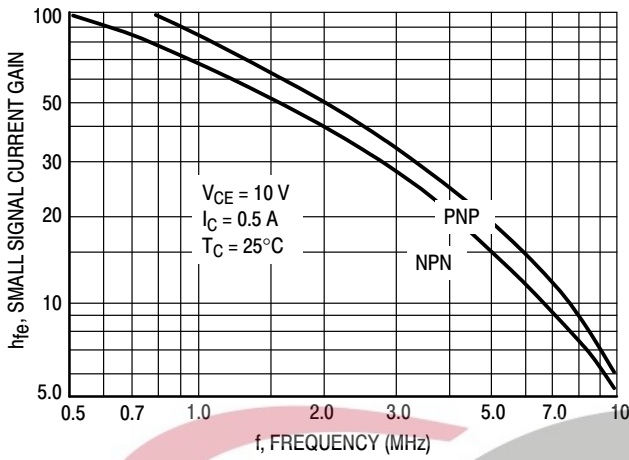

Figure 6. Small-Signal Current Gain

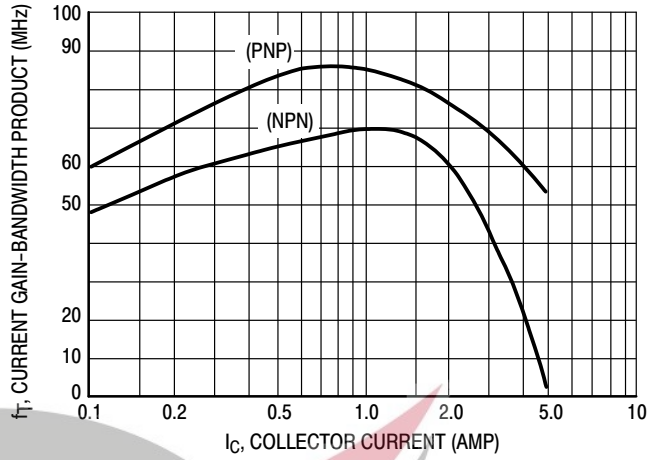

Figure 7. Current Gain-Bandwidth Product

NPN — MJE15028 MJE15030

PNP — MJE15029 MJE15031

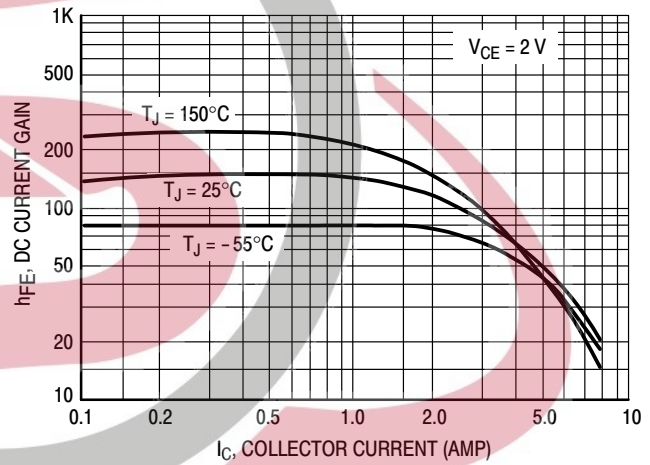
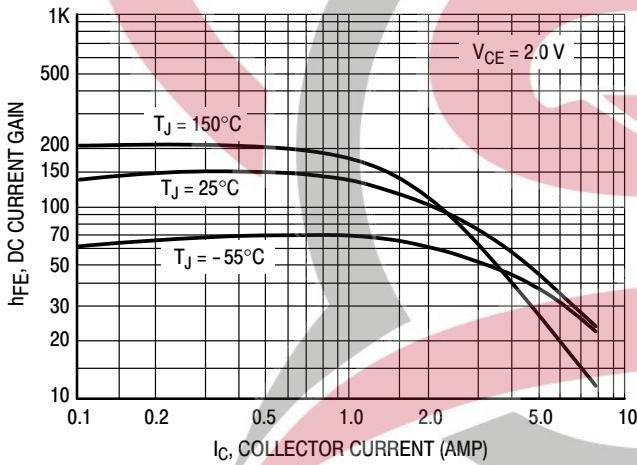

Figure 8. DC Current Gain

NPN

PNP

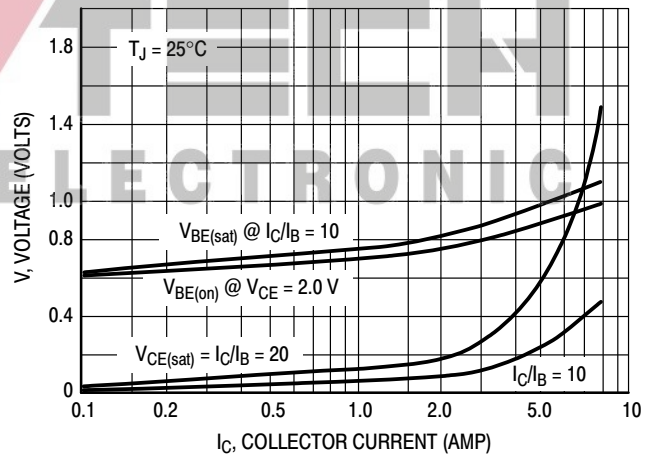
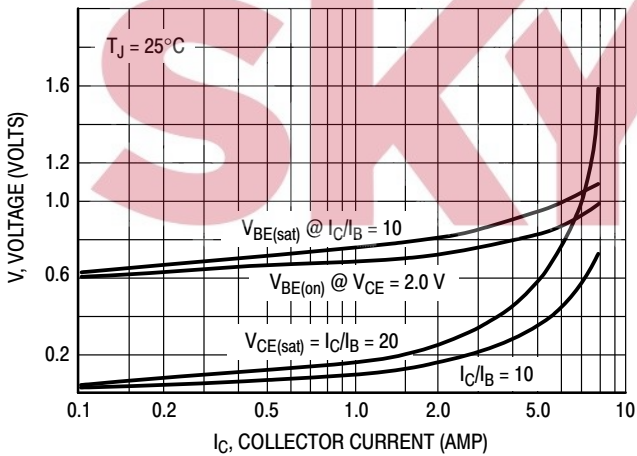

Figure 9. "On" Voltage

MJE15028, MJE15030 (NPN), MJE15029, MJE15031 (PNP)

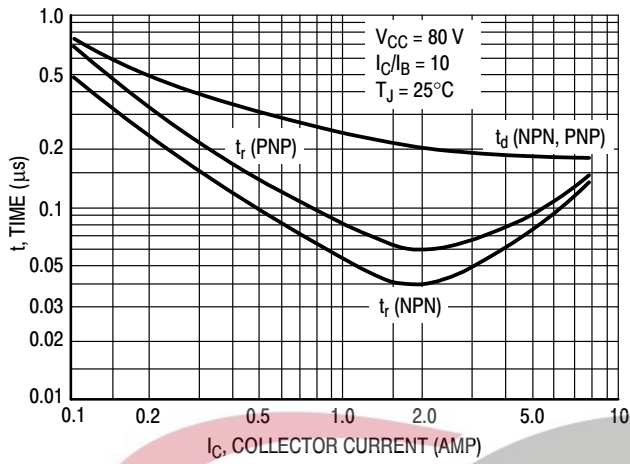

Figure 10. Turn-On Times

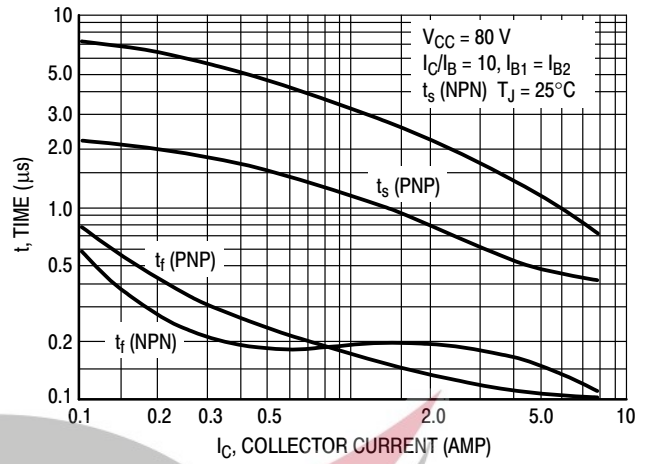

Figure 11. Turn-Off Times

ORDERING INFORMATION

Device	Package	Shipping
MJE15028G	TO-220 (Pb-Free)	50 Units / Rail
MJE15029G	TO-220 (Pb-Free)	50 Units / Rail
MJE15030G	TO-220 (Pb-Free)	50 Units / Rail
MJE15031G	TO-220 (Pb-Free)	50 Units / Rail

SKYTECH
ELECTRONIC

MECHANICAL CASE OUTLINE PACKAGE DIMENSIONS

ON Semiconductor®



TO-220 CASE 221A-09 ISSUE AJ

DATE 05 NOV 2019

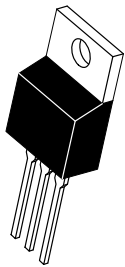

SCALE 1:1

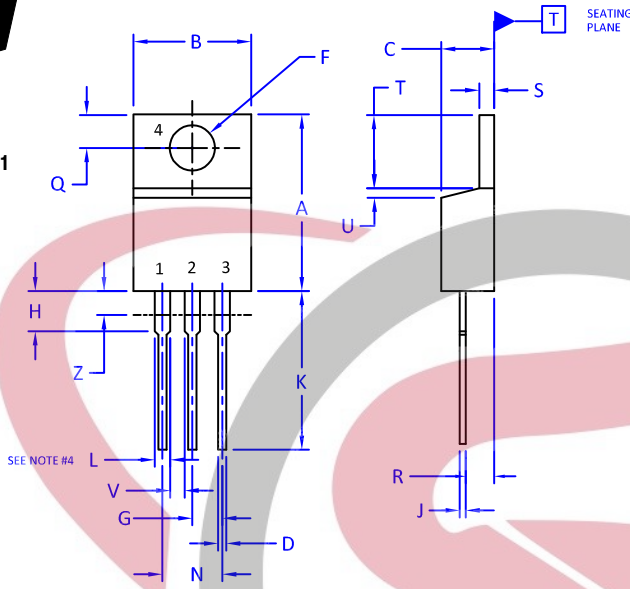

NOTES:

1. DIMENSIONING AND TOLERANCING PER ANSI Y14.5M, 2009.
2. CONTROLLING DIMENSION: INCHES
3. DIMENSION Z DEFINES A ZONE WHERE ALL BODY AND LEAD IRREGULARITIES ARE ALLOWED.
4. MAX WIDTH FOR F102 DEVICE = 1.35MM

DIM	INCHES		MILLIMETERS	
	MIN.	MAX.	MIN.	MAX.
A	0.570	0.620	14.48	15.75
B	0.380	0.415	9.66	10.53
C	0.160	0.190	4.07	4.83
D	0.025	0.038	0.64	0.96
F	0.142	0.161	3.60	4.09
G	0.095	0.105	2.42	2.66
H	0.110	0.161	2.80	4.10
J	0.014	0.024	0.36	0.61
K	0.500	0.562	12.70	14.27
L	0.045	0.060	1.15	1.52
N	0.190	0.210	4.83	5.33
Q	0.100	0.120	2.54	3.04
R	0.080	0.110	2.04	2.79
S	0.045	0.055	1.15	1.41
T	0.235	0.255	5.97	6.47
U	0.000	0.050	0.00	1.27
V	0.045	---	1.15	---
Z	---	0.080	---	2.04

STYLE 1:
PIN 1. BASE
2. COLLECTOR
3. EMITTER
4. COLLECTOR

STYLE 2:
PIN 1. BASE
2. EMITTER
3. COLLECTOR
4. EMITTER

STYLE 3:
PIN 1. CATHODE
2. ANODE
3. GATE
4. ANODE

STYLE 4:
PIN 1. MAIN TERMINAL 1
2. MAIN TERMINAL 2
3. GATE
4. MAIN TERMINAL 2

STYLE 5:
PIN 1. GATE
2. DRAIN
3. SOURCE
4. DRAIN

STYLE 6:
PIN 1. ANODE
2. CATHODE
3. ANODE
4. CATHODE

STYLE 7:
PIN 1. CATHODE
2. ANODE
3. CATHODE
4. ANODE

STYLE 8:
PIN 1. CATHODE
2. ANODE
3. EXTERNAL TRIP/DELAY
4. ANODE

STYLE 9:
PIN 1. GATE
2. COLLECTOR
3. EMITTER
4. COLLECTOR

STYLE 10:
PIN 1. GATE
2. SOURCE
3. DRAIN
4. SOURCE

STYLE 11:
PIN 1. DRAIN
2. SOURCE
3. GATE
4. SOURCE

STYLE 12:
PIN 1. MAIN TERMINAL 1
2. MAIN TERMINAL 2
3. GATE
4. NOT CONNECTED

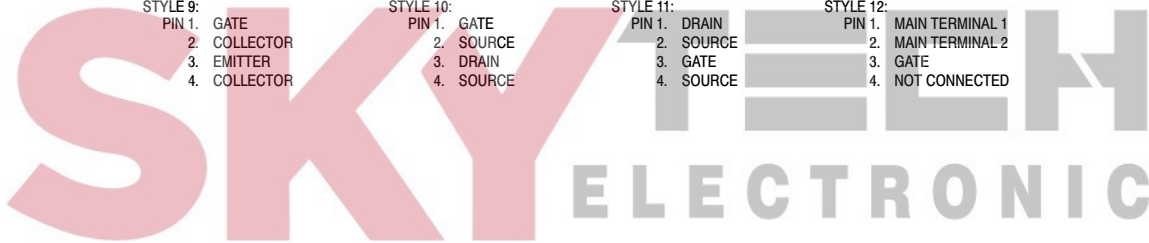

DOCUMENT NUMBER:	98ASB42148B	Electronic versions are uncontrolled except when accessed directly from the Document Repository. Printed versions are uncontrolled except when stamped "CONTROLLED COPY" in red.
DESCRIPTION:	TO-220	PAGE 1 OF 1

ON Semiconductor and ON are trademarks of Semiconductor Components Industries, LLC dba ON Semiconductor or its subsidiaries in the United States and/or other countries. ON Semiconductor reserves the right to make changes without further notice to any products herein. ON Semiconductor makes no warranty, representation or guarantee regarding the suitability of its products for any particular purpose, nor does ON Semiconductor assume any liability arising out of the application or use of any product or circuit, and specifically disclaims any and all liability, including without limitation special, consequential or incidental damages. ON Semiconductor does not convey any license under its patent rights nor the rights of others.

www.onsemi.com



SKY **TECH**
ELECTRONIC

ON Semiconductor and  are trademarks of Semiconductor Components Industries, LLC dba ON Semiconductor or its subsidiaries in the United States and/or other countries. ON Semiconductor owns the rights to a number of patents, trademarks, copyrights, trade secrets, and other intellectual property. A listing of ON Semiconductor's product/patent coverage may be accessed at www.onsemi.com/site/pdf/Patent-Marking.pdf. ON Semiconductor reserves the right to make changes without further notice to any products herein. ON Semiconductor makes no warranty, representation or guarantee regarding the suitability of its products for any particular purpose, nor does ON Semiconductor assume any liability arising out of the application or use of any product or circuit, and specifically disclaims any and all liability, including without limitation special, consequential or incidental damages. Buyer is responsible for its products and applications using ON Semiconductor products, including compliance with all laws, regulations and safety requirements or standards, regardless of any support or applications information provided by ON Semiconductor. "Typical" parameters which may be provided in ON Semiconductor data sheets and/or specifications can and do vary in different applications and actual performance may vary over time. All operating parameters, including "Typicals" must be validated for each customer application by customer's technical experts. ON Semiconductor does not convey any license under its patent rights nor the rights of others. ON Semiconductor products are not designed, intended, or authorized for use as a critical component in life support systems or any FDA Class 3 medical devices or medical devices with a same or similar classification in a foreign jurisdiction or any devices intended for implantation in the human body. Should Buyer purchase or use ON Semiconductor products for any such unintended or unauthorized application, Buyer shall indemnify and hold ON Semiconductor and its officers, employees, subsidiaries, affiliates, and distributors harmless against all claims, costs, damages, and expenses, and reasonable attorney fees arising out of, directly or indirectly, any claim of personal injury or death associated with such unintended or unauthorized use, even if such claim alleges that ON Semiconductor was negligent regarding the design or manufacture of the part. ON Semiconductor is an Equal Opportunity/Affirmative Action Employer. This literature is subject to all applicable copyright laws and is not for resale in any manner.

PUBLICATION ORDERING INFORMATION

LITERATURE FULFILLMENT:

Email Requests to: orderlit@onsemi.com

ON Semiconductor Website: www.onsemi.com

TECHNICAL SUPPORT

North American Technical Support:

Voice Mail: 1 800-282-9855 Toll Free USA/Canada

Phone: 011 421 33 790 2910

Europe, Middle East and Africa Technical Support:

Phone: 00421 33 790 2910

For additional information, please contact your local Sales Representative



Mouser Electronics

Authorized Distributor

Click to View Pricing, Inventory, Delivery & Lifecycle Information:

[ON Semiconductor:](#)

[MJE15028](#) [MJE15028G](#) [MJE15029](#) [MJE15029G](#) [MJE15030](#) [MJE15030G](#) [MJE15031](#) [MJE15031G](#)

